



Omni 20 for Power Station **Quick Start Guide**

POWER YOUR NEXT ADVENTURE

For more information visit our ***support*** page at www.omnicharge.co

AC OUTLET

Max output power: 100W

Double Press the Power Button to enter the menu and select Wall Socket.
Next, choose AC or HVDC.

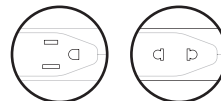

US/JP

EU

1. Choose 120 V AC/150V HVDC (EU model: 230V AC/300V HVDC) mode in the menu.

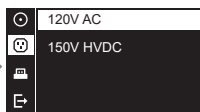
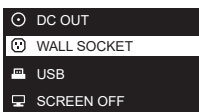

US/JP model

or

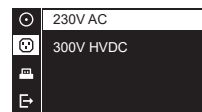

EU model

Note:

Only choose 150V HVDC/300V HVDC if you are using a switch mode power supply, such as a laptop's AC power adapter. Check our support page at www.omnicharge.co for more detailed information.

2. Turn on AC/HVDC, the icon should appear on the screen

AC 120V/230V AC output

HVDC 150V/300V HVDC output

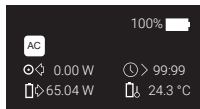

or

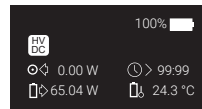

3. Power any device.



Laptop



TV



Drone



DSLR



Projector



And more

DC OUTPUT

1V - 24V with 0.1V Accuracy, up to 3.5A (70W max)



1. Find the correct voltage for your laptop from its power adaptor.

*Note: For more information visit our **support** page at www.omnicharge.co*

2. Set voltage through the menu

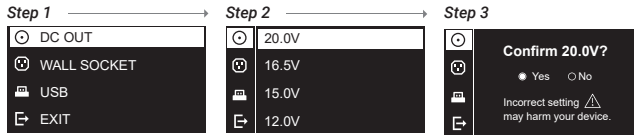

Note:

i. Omnicarge keeps 4 sets of preset voltage.

Press and hold the power button to change the preset voltage on step 3.

i. After step 1, you may also long press the USB button and directly jump to step 3.

3. DC icon will appear on the screen

DC Adjustable DC output

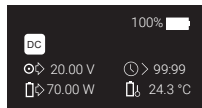

4. Power your device through DC port

DC to Surface
Connect Cable



DC to MagSafe 2 Cable



RAPID-CHARGING USB PORTS



USB Port 1: 5V/3A, USB Port 2: QC 3.0

1. Choose whether the USB output is On or Off when you turn on your Omnicharge



WIRELESS CHARGING



Charging your wireless device

1. Press USB Ports to activate wireless mode
2. Place your wireless device on the top of Omnicharge as shown in the illustration below. Make sure the center of the device is aligned over the center of the charging base. Charging will begin on contact.

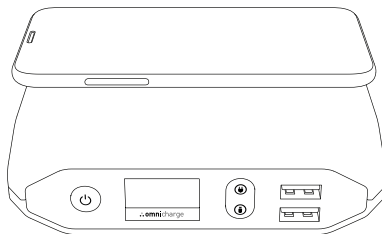

PORTS AND BUTTONS

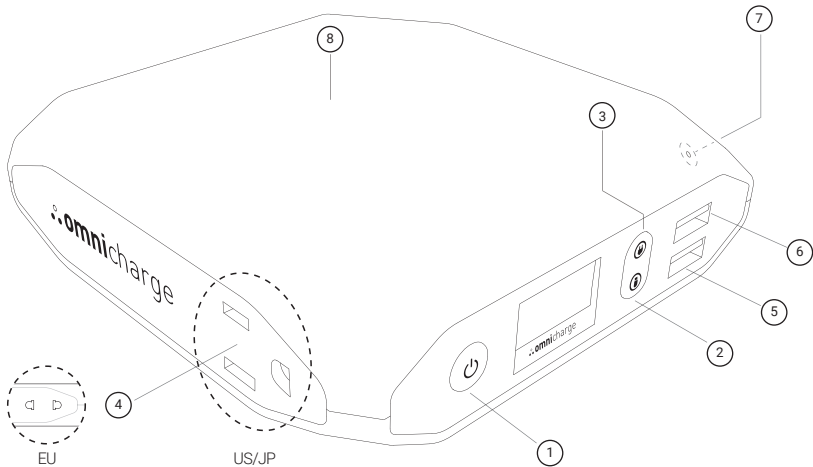



1. Power and Menu Button
2. USB Button
3. AC Outlet Button
4. AC Outlet (US/JP or EU version)





5. Quick Charge USB (Qualcomm 3.0 Compatible)
6. 5V/3A USB Port
7. DC Output and Input (5.5 x 2.1mm Barrel Port)
8. Wireless Charging Base

BUTTON FUNCTIONS

MAIN CONTROLS

-  • Quick press to power on
-  • Long press to power off
-  • On/Off AC Outlet
-  • On/Off USB Ports (Long press to jump to DC output settings)

MENU CONTROLS

-  • Double press to enter the menu
-  • Quick press to select
-  • Move Up
-  • Move Down

SCREEN

OLED screen with real time metrics

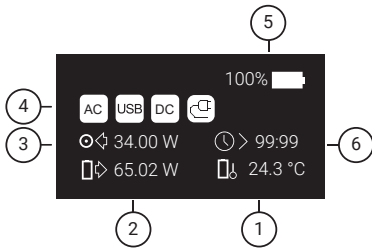

1. Battery Temperature
2. Battery Power Output (watt)
3. Power Input (watt)
4. Icon Display
6. Battery Level (+/- 1%)
7. DC power output (voltage)

MENU NAVIGATION

⊙ DC OUT

Turn on DC output and set the voltage.

⊕ WALL SOCKET

Choose whether the AC outlet will output 120V/230V or 150V/300V HVDC.

🔌 USB

Choose whether the USB output is On or Off when you turn on your Omnicharge.

📺 SCREEN OFF

Set the OLED screen auto turn-off time here. The default setting is 5 minutes.

🔌 AUTO SHUT OFF

Choose whether or not your Omnicharge will automatically shut off. The default setting is 5 minutes.

🌡️ TEMPERATURE

Choose Fahrenheit or Celsius here.

⊕ ABOUT

Find the model name, capacity, firmware version number and serial number here.

SCREEN ICON



120V/230V AC OUTPUT

120V/230V AC outlet is activated.



150V/300V HVDC OUTPUT

150V/300V HVDC (high voltage DC) is activated.



ADJUSTABLE DC OUTPUT

Adjustable 1V-24V DC is activated.



USB OUTPUT

USB ports are turned on.



WIRELESS CHARGING ACTIVATED



CHARGING INPUT

Your Omnicharge is being charged.



OPTIMAL CHARGING

Omnicharge is being charged at maximum power.



SOLAR CHARGING

Omnicharge is being charged from solar power.



LOW TEMPERATURE PROTECTION

Battery's temperature is too low and the charging circuit is shut off.



OVERPOWER PROTECTION

Your device is drawing too much power.
Omnicharge will limit or cut off its output power.



OVERHEATING PROTECTION

Battery or circuit boards' temperature is too high.
Omnicharge will limit or cut off its input and output power.

NOTICE:

Using your Omnicharge

When you're using your Omnicharge, it is normal for the surface to get warm. For prolonged use, place your Omnicharge on a flat, stable surface with adequate ventilation. When your Omnicharge's battery is low, please put it back in the power station for recharging. The configuration will be restored after recharging.

Carrying Your Omnicharge

If you carry your Omnicharge in a bag or briefcase, make sure there are no loose objects that could accidentally get inside the Omnicharge through airflow vents or get stuck inside a port.

Storing Your Omnicharge

If you are going to store your Omnicharge for an extended period of time, keep it in a cool location (ideally, 71°F or 22°C) and charge the battery to 100%. When storing your Omnicharge for more than 5 months, charge the battery to 100% every six months.

THANK YOU

www.omnicharge.co

CUSTOMER SUPPORT

All Omnicharge products have gone through quality inspection. If you find your Omnicharge or any Omnicharge accessory is experiencing or demonstrating any abnormal behavior, immediately stop all product use and contact us at **support@omnicharge.co**.

FOLLOW US



<https://www.facebook.com/omnicharge>



<https://www.instagram.com/omnicharge>



<https://www.youtube.com/c/omnicharge>



https://twitter.com/omni_charge
